

Makita

アメリカ

Dust Collector

MODEL 420S
(Dry type)

INSTRUCTION MANUAL

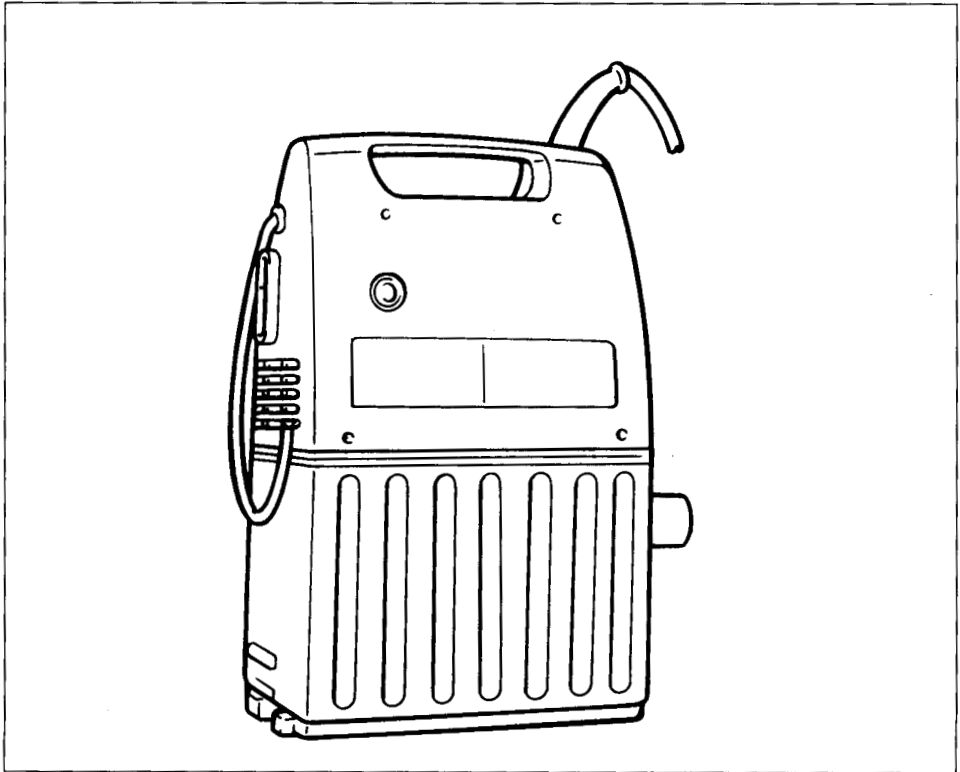

SPECIFICATIONS

Peak air flow	Sealed suction	Recoverable capacity	Hose length	Dimensions (L x W x H)	Net weight
1.2 m ³ /min. (42.4 cu.ft./min.)	1,200 mm (47") of water	2.2 ℓ	1.5 m (5 ft.)	240 mm x 140 mm x 340 mm (9-7/16" x 5-1/2" x 13-3/8")	2.9 kg (6.4 lbs)

- * Manufacturer reserves the right to change specifications without notice.
- * Note: Specifications may differ from country to country.

IMPORTANT SAFETY INSTRUCTIONS

WARNING: When using dust collector, safety precautions should always be followed to reduce the risk of fire, electric shock, and personal injury, including the followings:

READ ALL INSTRUCTIONS BEFORE USING THIS DUST COLLECTOR.

1. **PROPER GROUNDING.** This tool should be grounded while in use to protect the operator from electric shock. Connect to a properly grounded outlet only. See "Grounding Instructions".
2. **GUARD AGAINST ELECTRIC SHOCK.** Prevent body contact with grounded surfaces. For example; pipes, radiators, ranges, refrigerator enclosures.
3. This dust collector is intended for commercial use.
4. Do not use the dust collector without the filter. Replace a damaged filter immediately.
5. **EXTENSION CORDS:** Use only three-wire extension cords which have three-prong grounding-type plugs and three-pole receptacles which accept the tool's plug. For outdoor applications require an extension cord suitable for outdoor use. Replace or repair damaged or worn cord immediately.
6. **VOLTAGE WARNING:** Before connecting the dust collector to a power source (receptacle, outlet, etc.) be sure the voltage supplied is the same as that specified on the nameplate of the dust collector. A power source with voltage greater than that specified for the dust collector can result in **SERIOUS INJURY** to the user — as well as damage to the dust collector. If in doubt, **DO NOT PLUG IN THE DUST COLLECTOR.** Using a power source with voltage less than the nameplate rating is harmful to the motor.
7. Do not handle plug or dust collector with wet hands.
8. Always switch off and unplug the dust collector after each use and when power fails.
9. Wear a dust mask during dusty operations and a special respirator when vacuuming anything which may possibly endanger your breathing.
10. This is a dry pick-up backpack type dust collector for collecting dust exhausted from various types of electric power tools such as rotary hammers and sanders. Do not attempt to pick up liquids, wet dirt, flammable materials, sparks, fire works, lighted cigarettes, hot ashes, sharp materials such as razors, needles, broken glass or the like.
11. Do not vacuum toxic, carcinogenic, combustible or other hazardous materials such as asbestos, arsenic, barium, beryllium, lead, pesticides or other health endangering materials.
12. **NEVER USE THE DUST COLLECTOR IN THE VICINITY OF GASOLINE, GAS, PAINT, ADHESIVES OR OTHER HIGHLY EXPLOSIVE SUBSTANCES.** The

switch emits sparks when turned ON and OFF, and so does the motor commutator during operation. A dangerous explosion may result.

13. Do not allow to be used as a toy. Close attention is necessary when used by or near children.
14. Use only as described in this manual. Use only MAKITA's recommended attachments.
15. Never use the dust collector in the rain. When not in use, store the dust collector indoors.
16. Do not use close to heat source (stoves, etc.). This can cause discoloration and/or damage to the dust collector enclosures.
17. Do not block cooling vents or intake hole during operation. Do not attempt to pick up large items which may clog the dust collector.
18. Keep proper footing and balance at all times.
19. Use extra care when cleaning on stairs.
20. **DON'T ABUSE CORD.** Never carry the dust collector by cord or yank it to disconnect from receptacle. Keep cord away from heat, oil, and sharp edges. Inspect cords periodically and if damaged, have repaired by authorized service facility.
21. Do not fold, tug nor step on the hose.
22. Stop the dust collector immediately if you notice poor performance, unusual vibrations or anything abnormal during operation.
23. **DISCONNECT THE DUST COLLECTOR.** When not in use, before servicing, and when changing accessories.
24. Use the cleaning lever frequently to clear the dust from the filter. Empty the contents of the dust compartment before full.
25. Clean and service the dust collector immediately after each use to keep it in tiptop operating condition.
26. Wear hearing protection during extended periods of operations.
27. Never place the hose over or near your mouth or nostrils.
28. **REPLACEMENT PARTS.** When servicing, use only identical replacement parts.
29. Be kind to your dust collector. Rough handling can cause breakage of even the most sturdily built dust collector.
30. Wipe the dust collector off with a soft cloth dampened in detergent solution. Never use thinner or benzine. This can cause discoloration and cracks in the dust collector enclosures.

SAVE THESE INSTRUCTIONS.

GROUNDING INSTRUCTIONS

This appliance must be grounded. If it should malfunction or breakdown, grounding provides a path of least resistance for electric current to reduce the risk of electric shock. This appliance is equipped with a cord having an equipment-grounding conductor and grounding plug. The plug must be plugged into an appropriate outlet that is properly installed and grounded in accordance with all local codes and ordinances.

WARNING — Improper connection of the equipment-grounding conductor can result in a risk of electric shock. Check with a qualified electrician or service person if you are in doubt as to whether the outlet is properly grounded. Do not modify the plug provided with the appliance — if it will not fit the outlet, have a proper outlet installed by a qualified electrician.

This appliance is for use on a nominal 120-volt circuit, and has a grounded plug that looks like the plug illustrated in Fig. A. A temporary adapter that looks like the adapter illustrated in Fig. B and C may be used to connect this plug to a 2-pole receptacle as shown in Fig. B if a properly grounded outlet is not available. The temporary adapter should be used only until a properly grounded outlet (Fig. A) can be installed by a qualified electrician. The green colored rigid ear, lug, or the like extending from the adapter must be connected to a permanent ground such as a properly grounded outlet box cover. Whenever the adapter is used, it must be held in place by a metal screw.

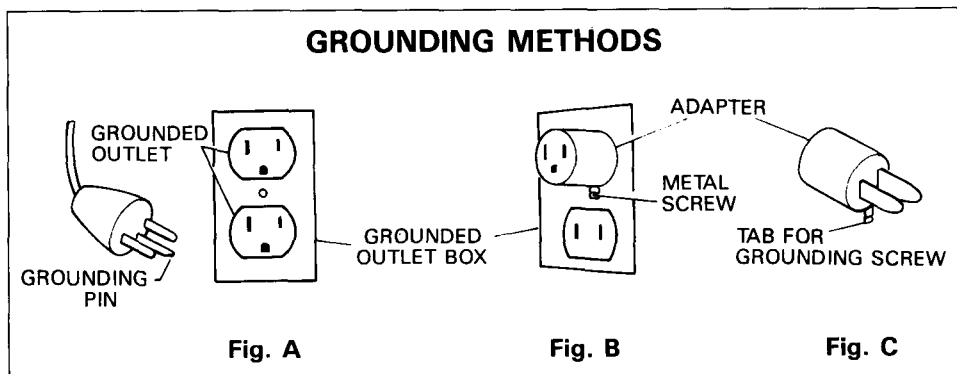

SAVE THESE INSTRUCTIONS.

Attaching shoulder strap and waist belt

Attach the shoulder strap to the dust collector using holes in the top and side of the dust collector as shown in the figures below. Always secure the shoulder strap using the buckles.

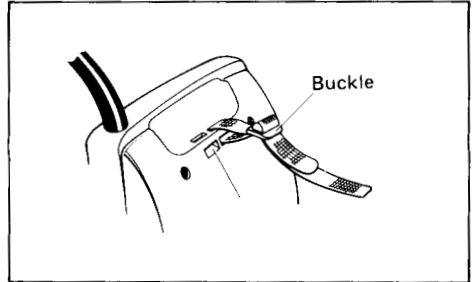
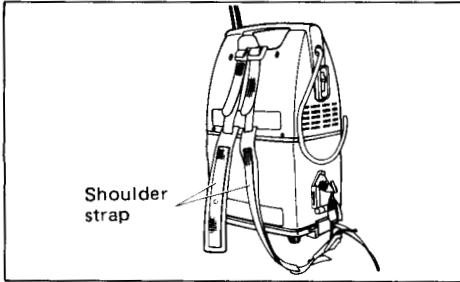

Attach the waist belt to the dust collector using holes in the side of the dust collector as shown at right.

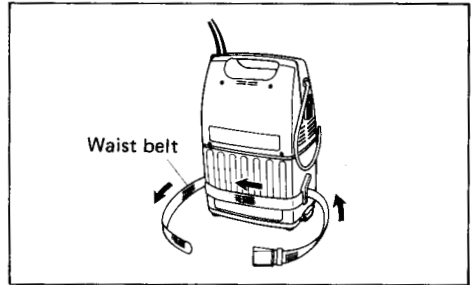

Hang the dust collector on your back and adjust the shoulder strap length so that you can carry the dust collector on your back comfortably.

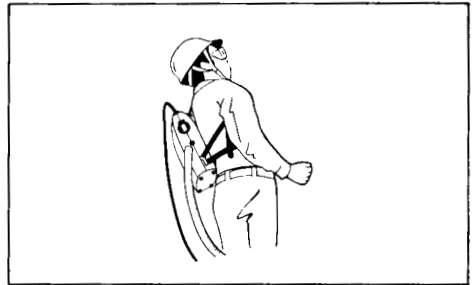

Installing hose

Hoses for this dust collector have a different size cuff on each end. This dust collector accepts either of the two cuffs, use them properly depending upon your power tool or accessory to be connected.

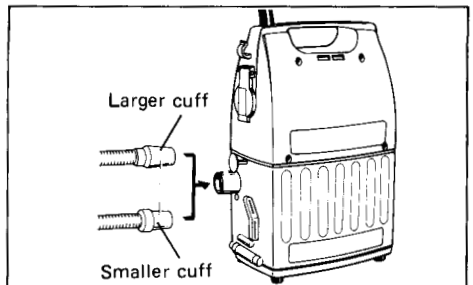

Operation

- 1) When using without your power tool connected:

To start the dust collector, press the "ON" side of the switch. Press the "OFF" side of the switch to stop.

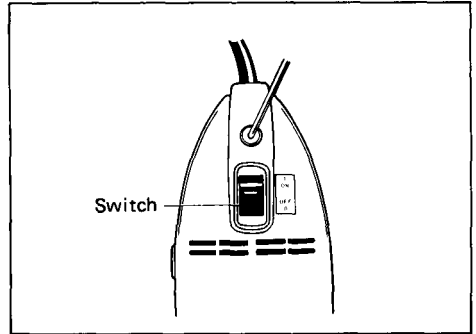

- 2) When using with your power tool connected:

This dust collector has an outlet for accepting the plug of your power tool. When your power tool is plugged into this outlet and the dust collector is switched on, the dust collector will be in its "AUTO-ON" condition and will start or stop automatically when you turn your power tool on or off.

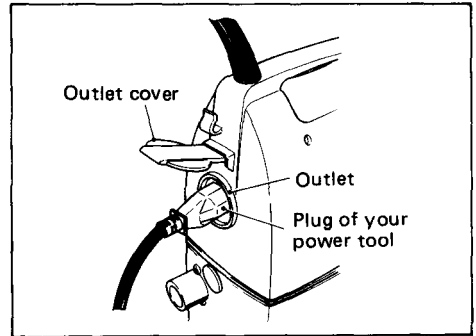

CAUTION:

- Maximum input of power tools which can be connected to the dust collector is 12 A. Check the power tool nameplate carefully before you attempt to connect the power tool.
- Always be sure that the dust collector and your power tool are switched off and unplugged before connecting your power tool to the dust collector.

Overload protector

The overload protector on the dust collector automatically cuts out to stop the dust collector and your power tool, whenever heavy work is prolonged. If this occurs, switch off both the dust collector and your power tool, and wait 20 – 30 seconds before pressing the restart button to resume operation.

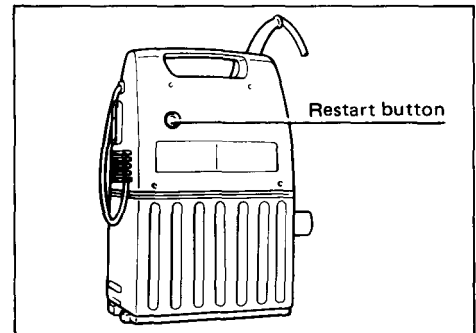

CAUTION:

Do not keep the restart button pressed with tape, etc.

Cord hook

Use the convenient cord hook as shown at right to prevent the power tool cord from dangling around your legs. Your legs may get tangled with the dangling cord, causing severe injury to you.

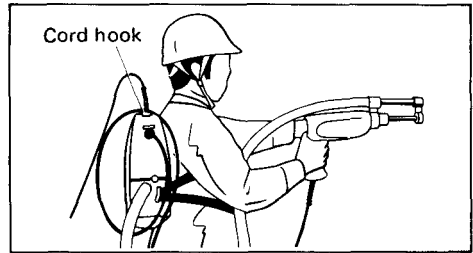

Cleaning lever

A clogged filter causes poor suction performance and potential damage to the motor. Occasionally use the cleaning lever to clear the dust from the filter. If suction performance becomes poor, move the cleaning lever back and forth about ten times after turning off the dust collector. Suction performance will recover.

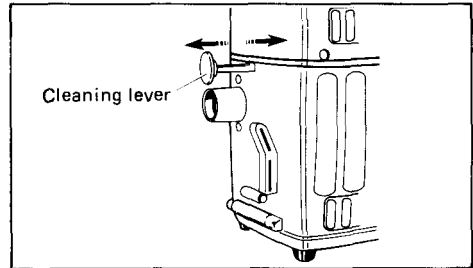

CAUTION:

Never apply excessive pressure to the cleaning lever. It may be broken.

Emptying out dust and dirt

CAUTION:

Always switch off and unplug the dust collector before emptying out dust and dirt.

Move the cleaning lever back and forth about ten times to clear the dust from the filter. Unbuckle and open the dust compartment cover. Empty the contents of the dust compartment. Always close the dust compartment cover securely with a little click after emptying out dust and dirt.

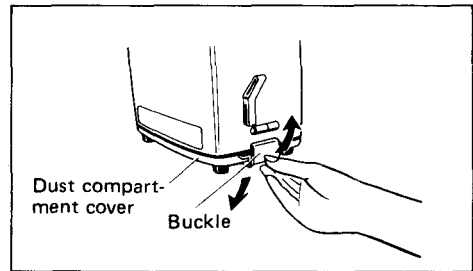

Hook

This dust collector is equipped with a convenient large hook. Use it for hanging the dust collector from a beam, scaffold, etc. However, never hang the dust collector in slippery or insecure places. The dust collector may fall. This will cause damage to the dust collector and/or injury to you or somebody else.

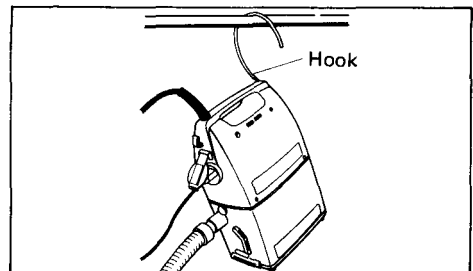

MAINTENANCE

CAUTION:

Always be sure that the tool is switched off and unplugged before attempting to perform inspection or maintenance.

Cleaning filter

If suction performance will not recover enough even after you use the cleaning lever to clear the dust from the filter and empty out the dust and dirt, proceed as follows to clean the filter.

Loosen the four screws which secure the filter. Remove the filter from the dust compartment.

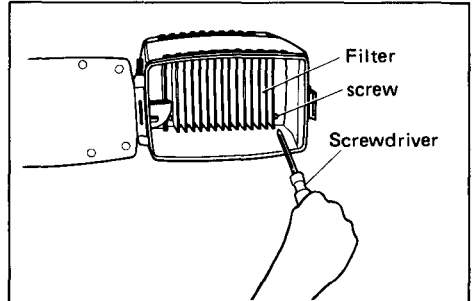

Hose the filter with clean water to remove any dust from it. Be careful not to damage the filter with a brush, stick or the like. Never perform this step near any source of electricity.

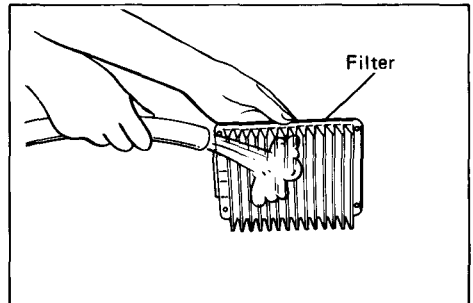

Allow the filter to dry thoroughly in the shade before reinstalling the filter in the dust collector. To install the filter, pull the cleaning lever until its end recedes as far back as the hole in the dust compartment as shown at right. Then insert the filter into the dust compartment. Secure the filter by tightening the four screws.

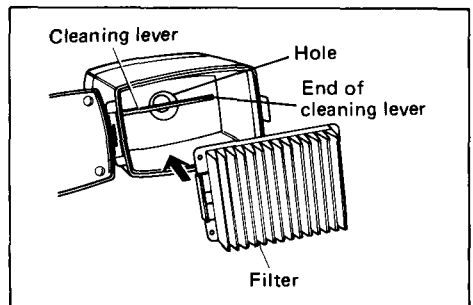

To maintain product **SAFETY** and **RELIABILITY**, repairs, carbon brush inspection and replacement, any other maintenance or adjustment should be performed by Makita Authorized or Factory Service Centers, always using Makita replacement parts.

ACCESSORIES

CAUTION:

These accessories or attachments are recommended for use with your Makita tool specified in this manual. The use of any other accessories or attachments might present a risk of injury to persons. The accessories or attachments should be used only in the proper and intended manner.

● Hose

Part No. 150269-7 (1.5 m : 4.9 ft)

Part No. 150327-9 (3 m : 9.8 ft)

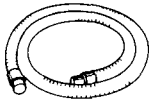

● Nozzle assembly

Part No. 122234-6

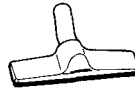

● Belt assembly

Part No. 122416-0

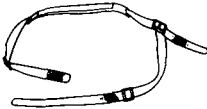

● Waist belt

Part No. 163335-1



● Straight pipe

Part No. 412040-0



● Round brush

Part No. 410539-9



(Use with rubber sleeve 25-32)

● Shelf brush

Part No. 410738-3

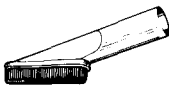



● Corner nozzle

Part No. 411891-8

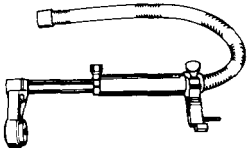
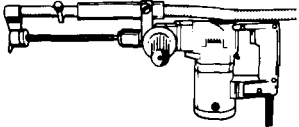

The following dust extractor attachments, joints and sleeves are available for use with some types of Makita rotary hammers, finishing sander and random orbit sander.

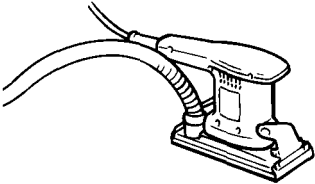
Description	Applicable model	
 <p data-bbox="132 422 378 470">Dust extractor attachment Part No. 192176-8</p>	<p data-bbox="453 290 624 363">Rotary hammers HR1821, HR2000 HR2511</p>	
 <p data-bbox="156 683 352 730">Rubber sleeve 18-21 Part No. 422021-6</p>	<p data-bbox="453 542 655 654">Finishing sander 9036 Random orbit sander BO5000</p>	

NOTE:

Makita concrete planer Model PC1100, belt sander Model 9401 and wheel sander Model 9741 can be connected directly to this dust collector without any joints and sleeves.

DUST COLLECTOR Model 420S

Type1

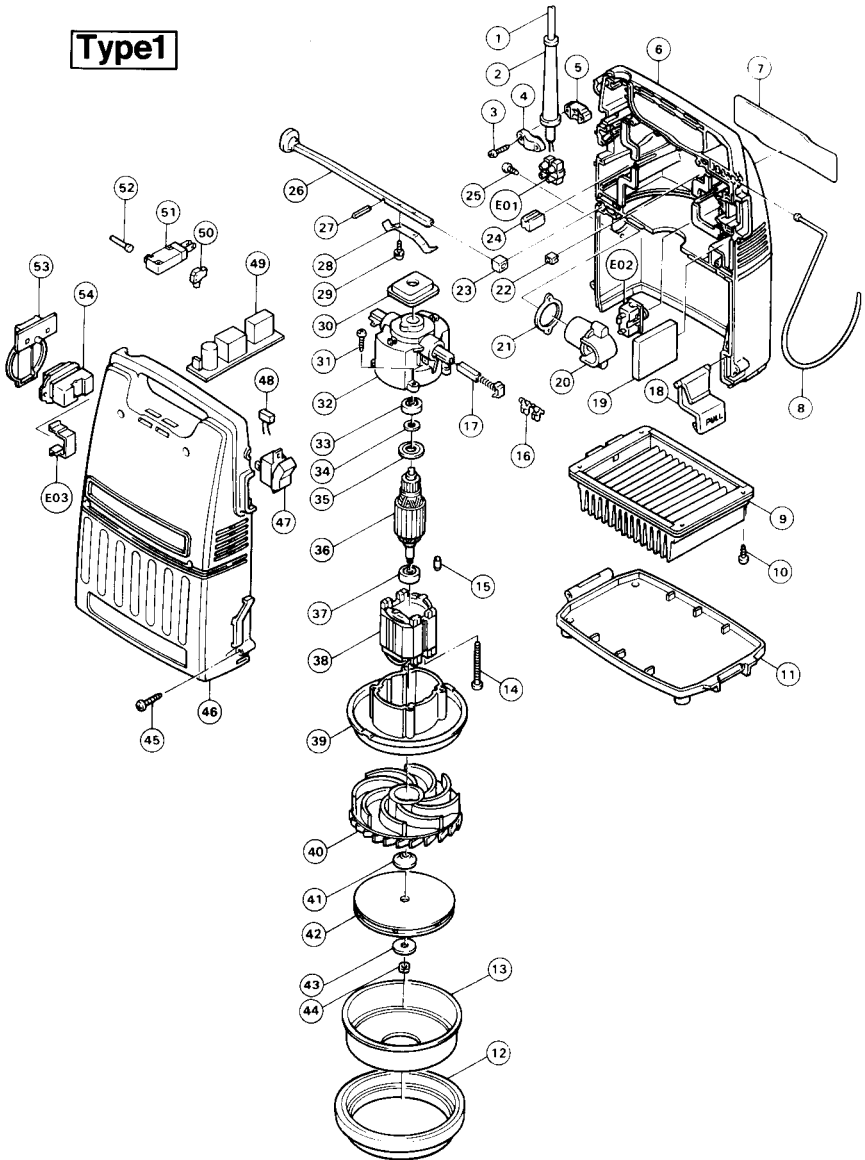

Note: The switch and other part configurations may differ from country to country.

ITEM NO.	NO. USED	DESCRIPTION	ITEM NO.	NO. USED	DESCRIPTION
MACHINE			MACHINE		
1	1	Cord	30	1	Support Cover
2	1	Cord Guard	31	4	Tapping Screw BT 4x20
3	2	Tapping screw 4x18	32	1	Terminal Base Complete
4	1	Strain Relief	33	1	Ball Bearing 607LLB
5	1	Strain Relief	34	1	Flat Washer 7
6	1	Housing Set (With Item 46)	35	1	Insulation Washer
7	1	Name Plate	36	1	ARMATURE ASSEMBLY (With Item 33 - 37)
8	1	Hook	37	1	Ball Bearing 608DDW
9	1	Main Filter	38	1	Field
10	4	Tapping screw 4x18	39	1	Bracket
11	1	Under Cover	40	1	Return Vane
12	1	Support Ring	41	1	Flange
13	1	Fan Cover	42	1	Fan 94
14	2	Tapping Screw BT 4x50	43	1	Washer 6
15	1	Rubber Pin 4	44	1	Hex. Nut M6
16	4	Receptacle	45	6	Tapping Screw BT 4x30
17	2	Carbon Brush	46	1	Housing Set (With Item 6)
18	1	Buckle	47	1	Switch
19	2	Filter	49	1	Control Circuit
20	1	Innlet	50	1	Receptacle Sleeve
21	1	Packing B	51	1	Switch
22	2	Rubber Lock	52	1	Switch Lever
23	1	Packing A	53	1	Cap
24	2	Sealing Block	54	1	Consent
25	2	Tapping screw 4x16	E01	1	Terminal Block
26	1	Beater Shaft	E02	1	Current Relay
27	1	Spring Pin 2.5-16	E03	1	Holder
28	1	Beater			
29	2	Pan Head Screw M3x6 (With Washer)			

Note: The switch and other part specifications may differ from country to country.

MAKITA LIMITED ONE YEAR WARRANTY

Warranty Policy

Every Makita tool is thoroughly inspected and tested before leaving the factory. It is warranted to be free of defects from workmanship and materials for the period of ONE YEAR from the date of original purchase. Should any trouble develop during this one-year period, return the COMPLETE tool, freight prepaid, to one of Makita's Factory or Authorized Service Centers. If inspection shows the trouble is caused by defective workmanship or material, Makita will repair (or at our option, replace) without charge.

This Warranty does not apply where:

- repairs have been made or attempted by others;
- repairs are required because of normal wear and tear;
- The tool has been abused, misused or improperly maintained;
- alterations have been made to the tool.

IN NO EVENT SHALL MAKITA BE LIABLE FOR ANY INDIRECT, INCIDENTAL OR CONSEQUENTIAL DAMAGES FROM THE SALE OR USE OF THE PRODUCT. THIS DISCLAIMER APPLIES BOTH DURING AND AFTER THE TERM OF THIS WARRANTY.

MAKITA DISCLAIMS LIABILITY FOR ANY IMPLIED WARRANTIES, INCLUDING IMPLIED WARRANTIES OF "MERCHANTABILITY" AND "FITNESS FOR A SPECIFIC PURPOSE," AFTER THE ONE-YEAR TERM OF THIS WARRANTY.

This Warranty gives you specific legal rights, and you may also have other rights which vary from state to state. Some states do not allow the exclusion or limitation of incidental or consequential damages, so the above limitation or exclusion may not apply to you. Some states do not allow limitation on how long an implied warranty lasts, so the above limitation may not apply to you.

Makita Corporation

3-11-8, Sumiyoshi-cho,
Anjo, Aichi 446 Japan

883782 - 069

PRINTED IN JAPAN

1994 - 2 - N